

# Devon Breeze

## Side Panel Installation Instructions (Floor Installation Only)

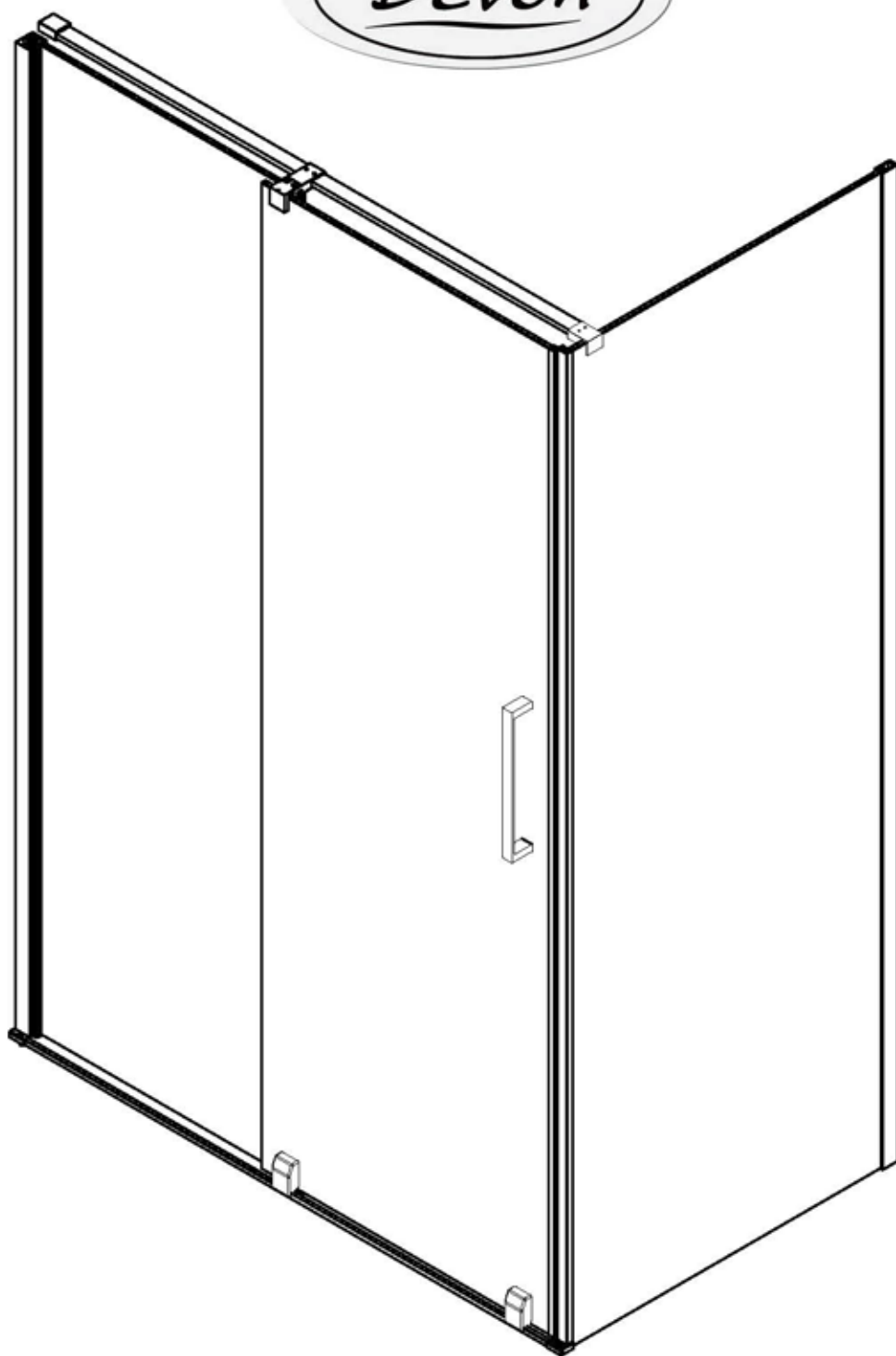

## ■ General Information

Please inspect the product immediately upon receipt for transit damage, missing packs/parts or manufacturing fault. Damage reported later cannot be accepted. Please handle the product with care avoiding knocks and shock loading to all sides and edges of the glass.

**Note: Safety glass can not be re-worked.**

## ■ Installation

Please read these instructions carefully before start of installation.

The wall post has up to 20mm of adjustment for out of true wall situations.

**Ensure that the shower tray is fitted level and that after assembly of enclosure there is a full and continuous bead of sealant between the top of the shower tray and the tile joint.**

Special care should be taken when drilling walls to avoid hidden pipes or electrical cables.

Note: This product is heavy and will require two people to install.

Please remove protective film from aluminium profiles before installation.

## ■ Shower Tray Installation

The shower tray must be sited against a structural wall.

Water proof walling or tiling should be fitted so that it sits on the top of the tray rim.

## ■ Aftercare Instructions

After use, your shower should be cleaned with soap and water. This is particularly important in hard water districts where insoluble lime salts may be deposited and allowed to build up. Cleaners of a gritty or abrasive nature should not be used. Care should be taken to avoid contact with strong chemicals such as organic solvents and strippers.

Glass cleaners can be used but with caution, if in doubt contact the supplier of the cleaner in question.

Please keep these instructions for aftercare and customer service details.

## Tools required

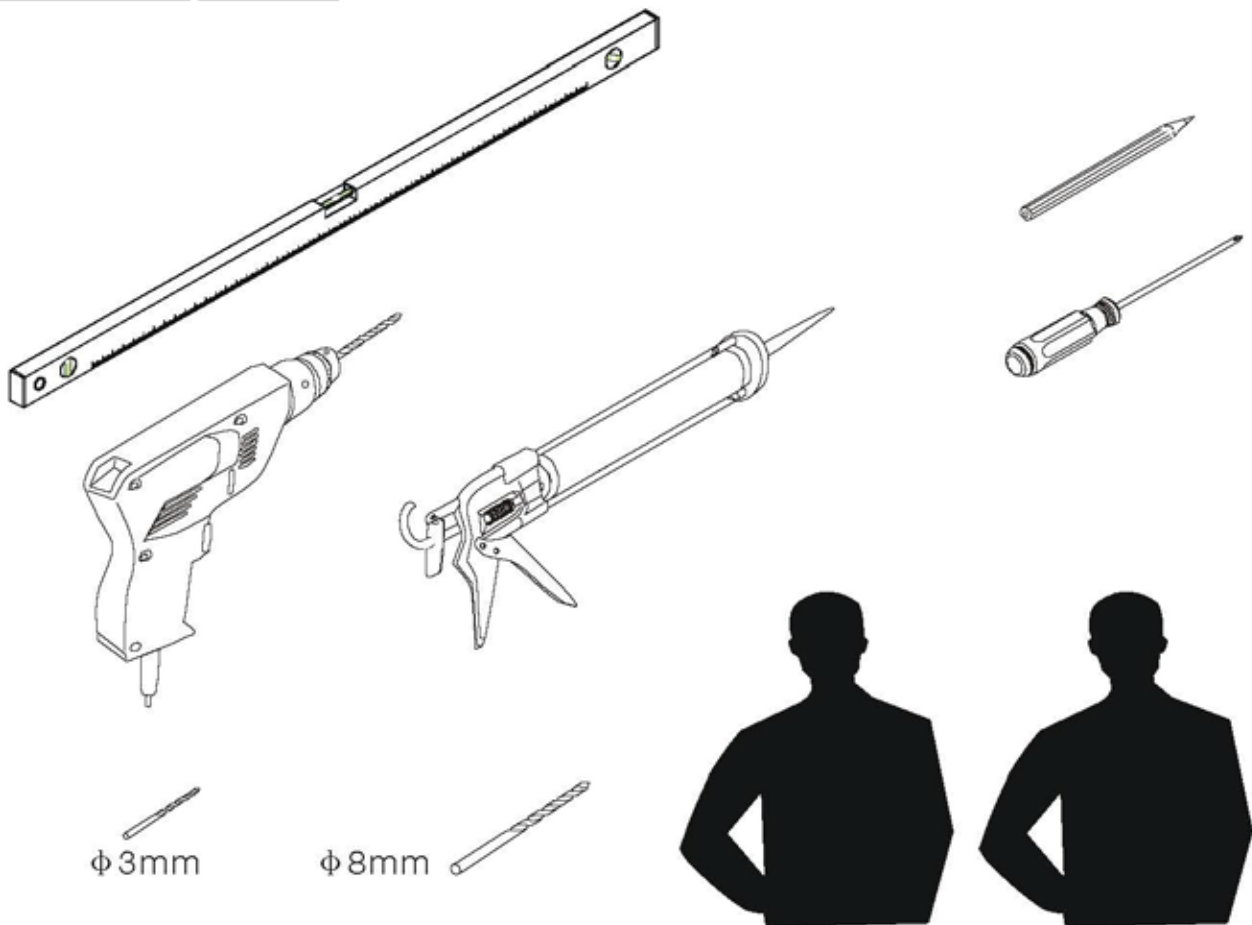

This product is heavy and will require two people to install.



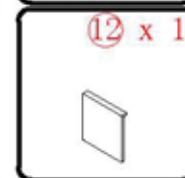
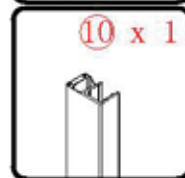
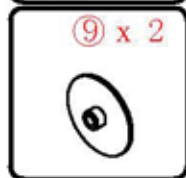
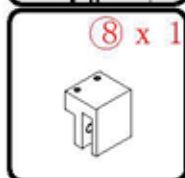
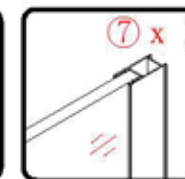
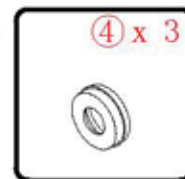
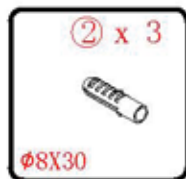
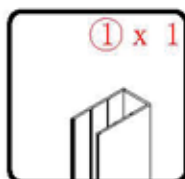
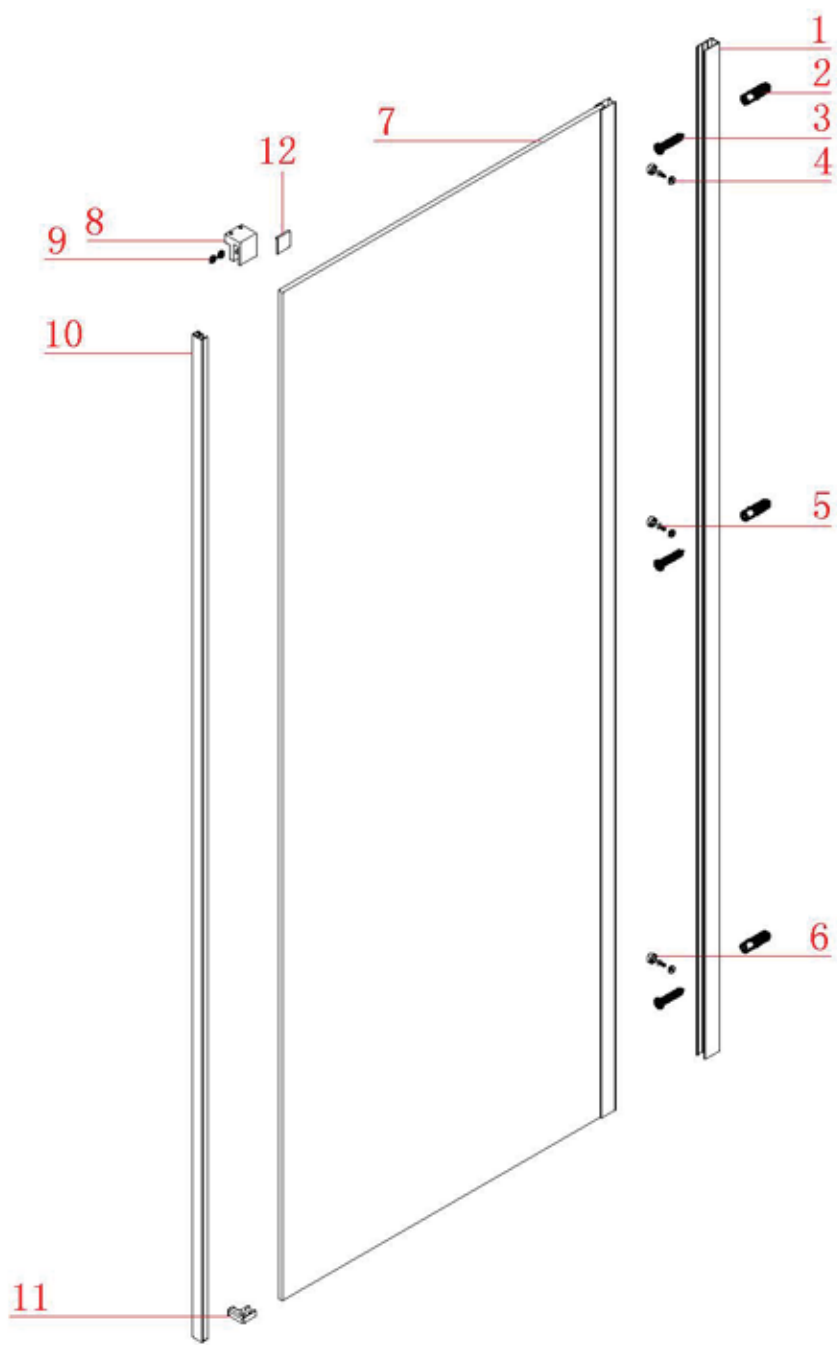

This product is heavy and will require two people to install.



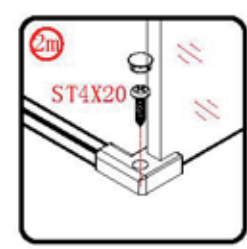
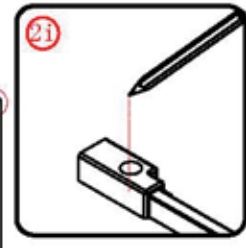
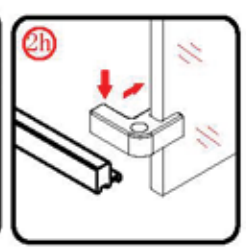
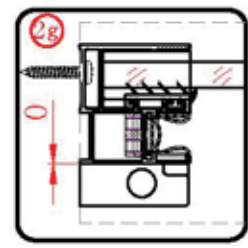
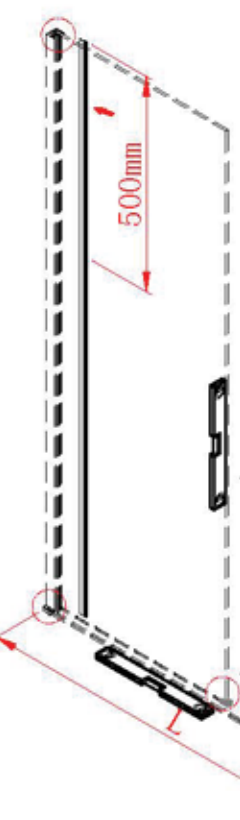
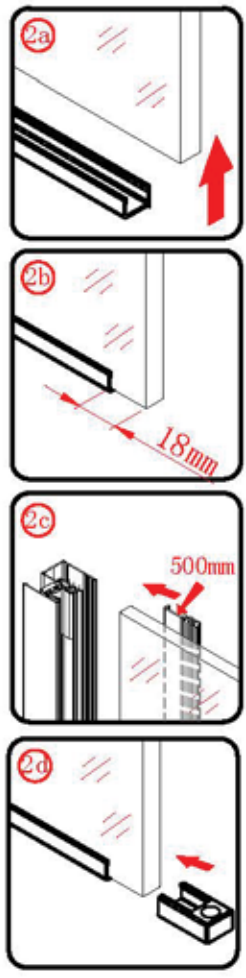
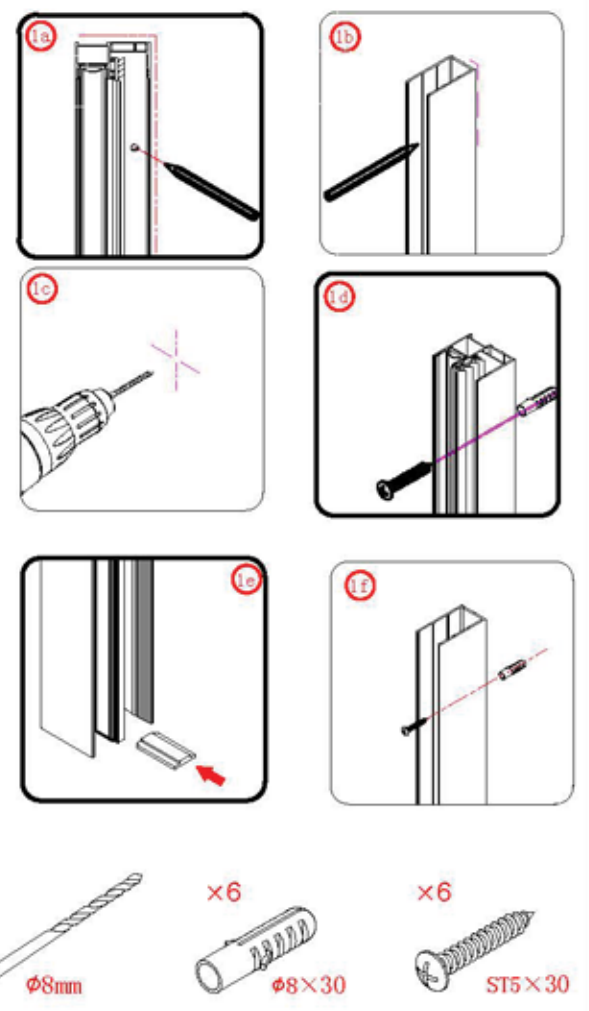
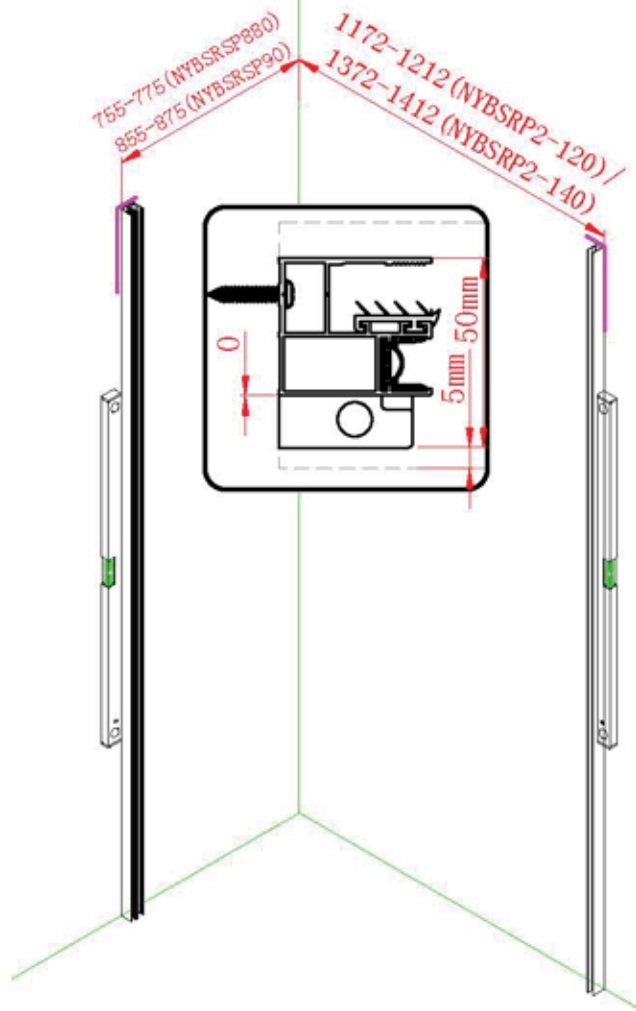

This product is heavy and will require two people to install.



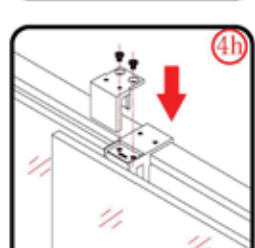
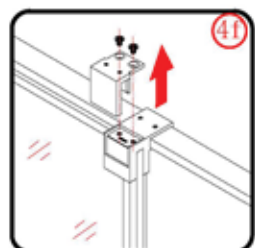
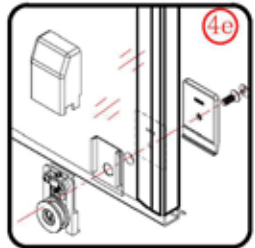
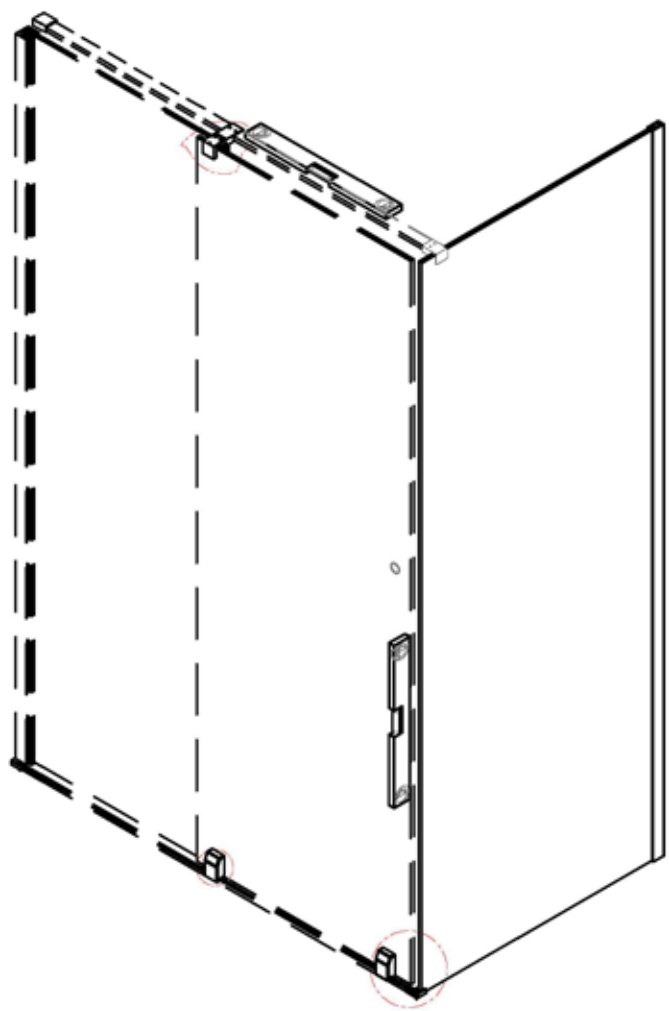
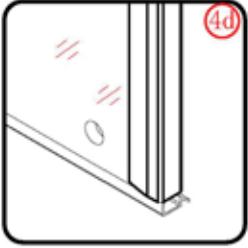
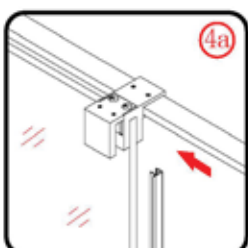
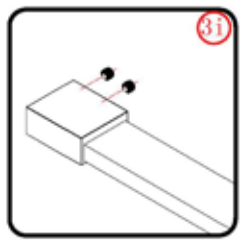
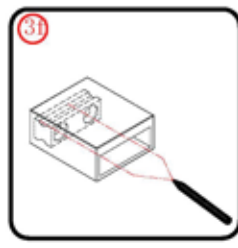
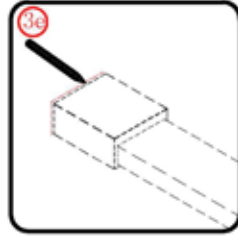
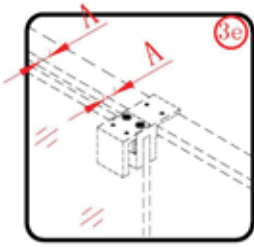
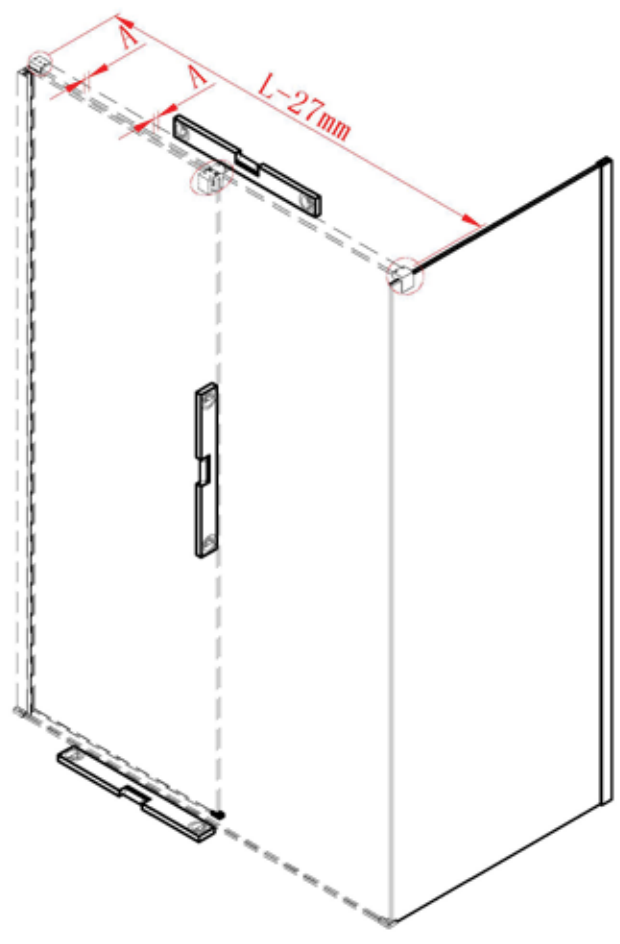
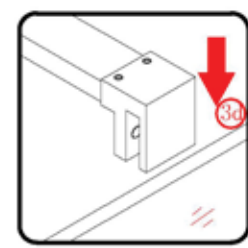
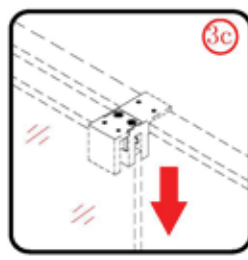
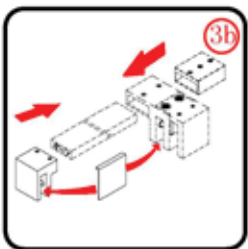
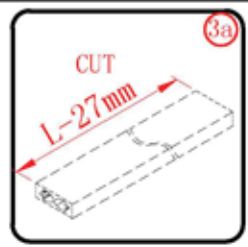

This product is heavy and will require two people to install.





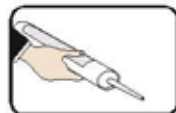
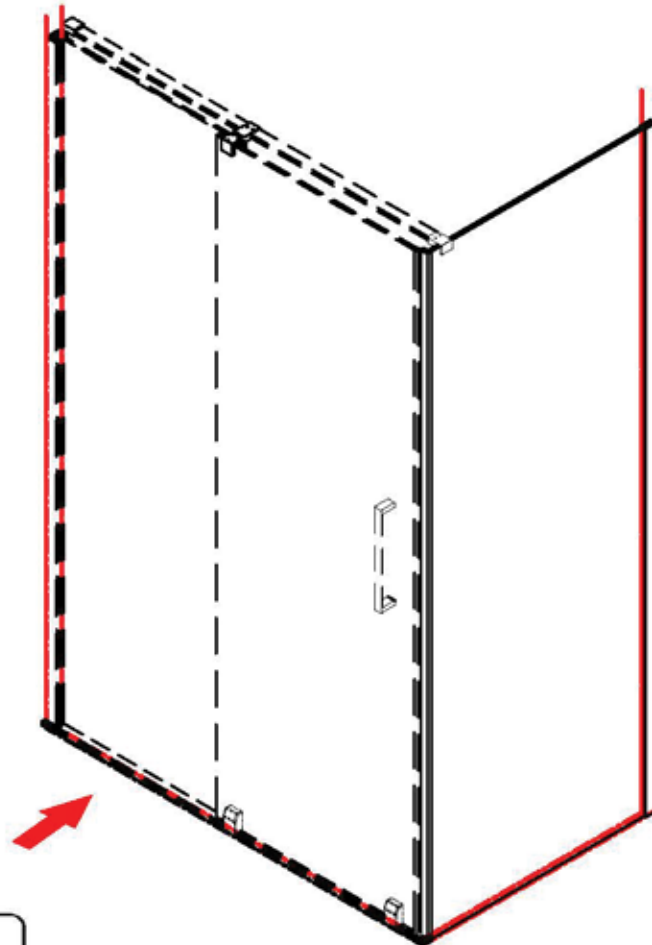
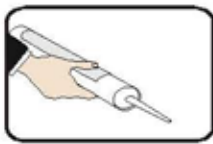
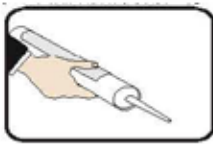
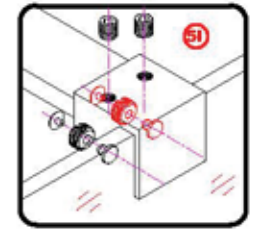
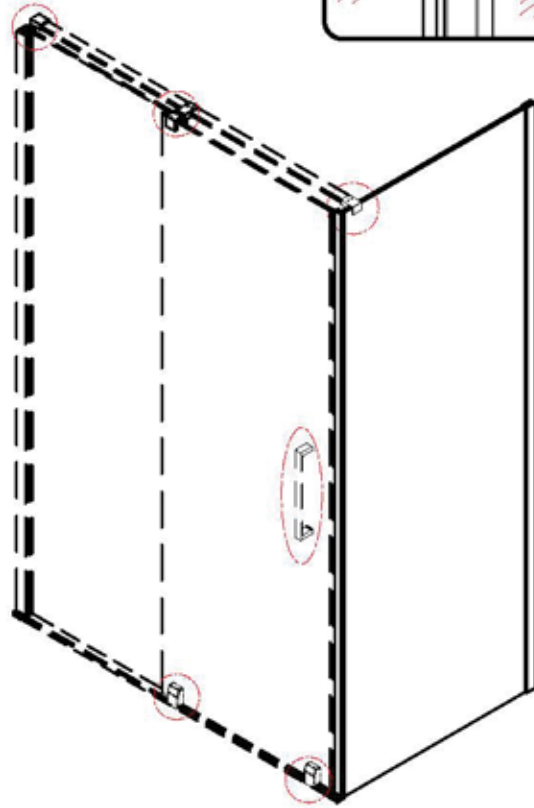
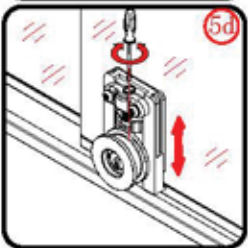
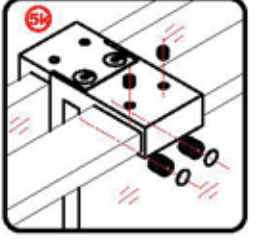
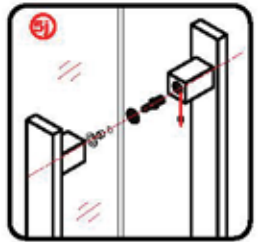
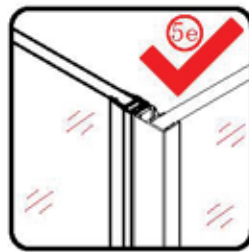

This product is heavy and will require two people to install.





6 ΧΡΟΝΙΑ  
ΕΓΓΥΗΣΗ

Σας ευχαριστούμε που επιλέξατε τις καμπίνες Devon. Τα υψηλά στάνταρ κατασκευής, σε συνδυασμό με την ποιότητα των υλικών, διασφαλίζουν την αντοχή των προϊόντων Devon.

Οι καμπίνες Devon καλύπτονται με εγγύηση 6 χρόνων. Οι γυάλινες επιφάνειες CLEAN GLASS καλύπτονται με εγγύηση 3 χρόνων.

Σε περίπτωση οποιουδήποτε ελαττώματος εγγυόμαστε υπό την επιφύλαξη των όρων που ακολουθούν, την επισκευή ή αντικατάσταση του προϊόντος, ή μερών αυτού.

ΓΙΑ ΤΗΝ ΚΑΤΑΧΩΡΗΣΗ ΤΗΣ ΕΓΓΥΗΣΗΣ, ΣΥΠΛΗΡΩΣΤΕ ΚΑΙ ΑΠΟΣΤΕΙΛΤΕ ΤΟ ΠΑΡΑΚΑΤΩ ΑΠΟΚΟΜΜΑ.

### Όροι εγγύησης

Είναι σημαντικό να ακολουθήσετε τις οδηγίες τοποθέτησης του κατασκευαστή.

Η εγγύηση καλύπτει όλες τις καμπίνες ντους από κατασκευαστικές σφάλειες για περίοδο 6 ετών.

Κάθε αξίωση βάσει της εγγύησης, πρέπει να μας γνωστοποιείται άμεσα εγγράφως και να συνοδεύεται από την απόδειξη αγοράς που δείχνει την ημερομηνία και το κατάστημα αγοράς. Σε περίπτωση αξίωσης στα πλαίσια της εγγύησης αυτής, διατηρούμε το δικαίωμα επιθεώρησης του προϊόντος.

Διατηρούμε το δικαίωμα τροποποίησης ή προσαρμογής των τεχνικών προδιαγραφών των προϊόντων μας ανά πάσα στιγμή. Όταν ένα πανομοιότυπο προϊόν δεν είναι πλέον διαθέσιμο, θα αντικαθιστάται με το πλησιέστερο ισοδύναμο.

Δεν καλύπτονται από την εγγύηση τα μέρη στα οποία προκλήθηκαν βλάβες ή φθορές από αιτίες οφειλόμενες σε:

- ελαττωματική ή λανθασμένη εγκατάσταση, κακή χρήση, αμέλεια ή φυσιολογική φθορά
- μη σωστή τήρηση των οδηγιών συντήρησης
- ζημία από επισκευές εκτελούμενες από μη εξουσιοδοτημένο προσωπικό

### Οδηγίες φροντίδας και συντήρησης

- Είναι σημαντικό να απομακρύνονται τα νερά από τις κρυστάλλινες επιφάνειες και τα πλαίσια μετά από κάθε χρήση και πριν στεγνώσουν για να αποφευχθεί η συσσώρευση αλάτων.
- Σκουπίστε τα κρύσταλλα με υαλοκαθαριστήρα ή ένα καθαρό μαλακό πανί ελαφρά βρεγμένο με νερό. Για τον καθαρισμό χρησιμοποιείτε ζεστό νερό και σαπούνι.
- Καθαριστικά τζαμιών μπορούν να χρησιμοποιηθούν αλλά με προσοχή.

### ΠΡΟΣΟΧΗ

- ΜΗ χρησιμοποιείται καθαριστικά για λείανση ή με κόκκους στο πλαίσιο ή στο κρύσταλλο.
- Να μεταχειρίζεστε τα κρύσταλλα της καμπίνας με ιδιαίτερη φροντίδα, αποφεύγοντας τα χτυπήματα στις ακμές.
- ΤΑ ΚΡΥΣΤΑΛΛΑ ΑΣΦΑΛΕΙΑΣ ΔΕΝ ΕΠΙΔΙΟΡΘΩΝΟΝΤΑΙ.

### Απόκομμα Εγγύησης

Μοντέλο: \_\_\_\_\_ Κατάστημα: \_\_\_\_\_

Ημερ / νία αγοράς: \_\_\_\_\_